

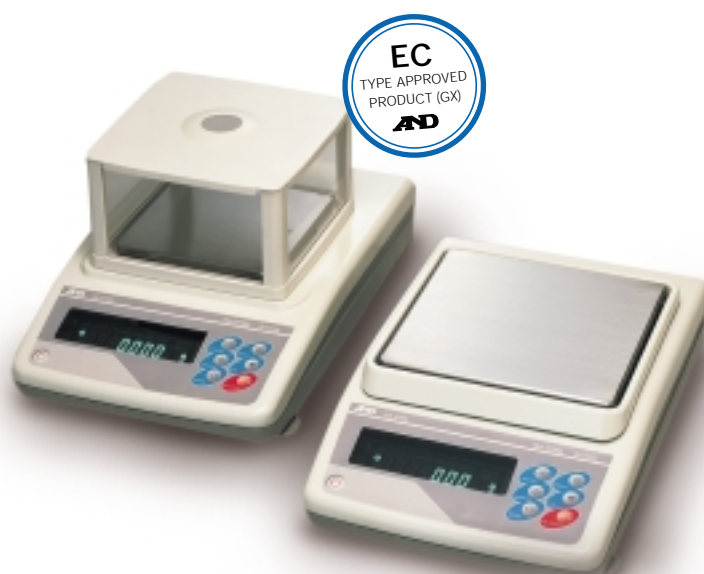

GX/GF Series

SHS Sensor Series
Precision Balances

Unrivalled in capacity and resolution:
210g / 0.001g ~ 8100g / 0.1g



AND ...Clearly a Better Value
A&D Instruments Ltd



Applications
Counting
Percentage
Animal weighing
Comparator
Density

GX/GF Series

Precision Balances

Multi-functional, precise, accurate, and long-lasting quality with a 4-year warranty. Just 1 second stabilisation time.

GX/GF – a complete range of robust, high-performance precision balances, with functions specifically designed to meet the exacting demands of chemical, pharmaceutical and scientific laboratories. Innovative and reliable SHS* technology offers you excellent performance day in day out.

An ergonomic design, small details such as a pullout user guide, and a host of standard features ensure exceptional ease-of-use. With a stabilisation time of approx. 1 second, the GX/GF series is one of the fastest precision balances in its class. And also one of the most accurate: with a capacity of 210g, e.g., the standard deviation is just 0.001g.

Thanks to its durable quality and a construction that has very few parts susceptible to wear, the GX/GF series is very economical.

All GX models have EC-type approval.

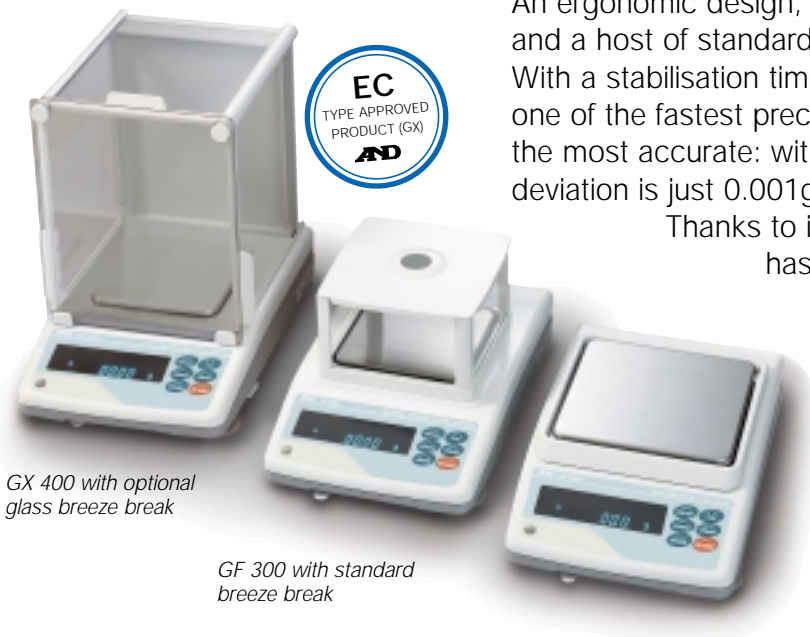

GX 400 with optional glass breeze break

GF 300 with standard breeze break

* SHS: Super Hybrid Sensor. A new highspeed reliable measuring system



Ranging from the animal-weighing program to the comparator function. Brilliant VFD display lets you read data easily.



Animal Weighing Mode

allows you to quickly and accurately determine the weight of any live or unstable subject.



Automatic Adjustable Environment Setting

adapts to the most suitable Environment Response Setting automatically with one-touch key operation.



Percentage Function

shows the percentage to the standard sample weight. Ideal for comparative weighing and moisture loss applications.

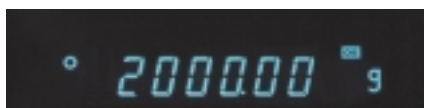

Standard Comparator Function

offers increased flexibility and compatibility for a vast number of applications. The results of the comparisons are indicated by HI, OK, and LO on the display.

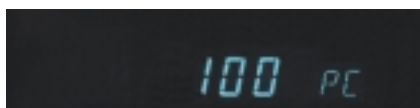

ACAI Counting Function

Automatic Counting Accuracy Improvement continuously recalculates and updates the average piece weight, ensuring optimum count accuracy even with small samples.

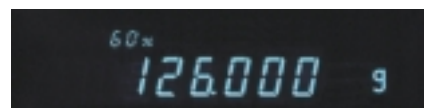

Overall Capacity Indication

is a unique and helpful feature of the GX/GF. By indicating how much of the balance's capacity has been used, the risk of overloading is minimised.

Options and Accessories

- GX-04 Comparator Output
- GX-06 Analog Output
- GX-10 Glass Breeze Break for the GX-200/400/600, GF-200/300
- GX-11 Glass Breeze Break for the GX-2000/4000/6100/6000/8000 GF-1200/2000/3000/6000
- GX-12 Animal Weighing Pan for the GX-400/600/2000/4000/6100/6000/8000, GF-1200/2000/3000/6000
- GX-13 Density Determination Kit for the GX-200/400/600, GF-200/300

Note: GX-04 and 06 are factory installed options.

- DP-1012 Basic Printer
- AD-8121 Dot Matrix Compact Printer
- AD-8920 Remote Display
- AX-PC09-BCS RS-232C Cable (9-pin) (GX)
- AX-PC25-BCS RS-232 Cable (25-pin) (GX)
- AX-KO1710-200 RX-232C Cable (25P-9P) (GF)
- AX-SW-128 Foot Switch
- AX-073002691-S Dust cover for GX-200/400/ 600 GF-200/300
- AX-073003692-S Dust cover for GX-2000/4000/ 6100/6000/8000, GF-1200/ 2000/ 3000/6000

Physical Dimensions (mm)

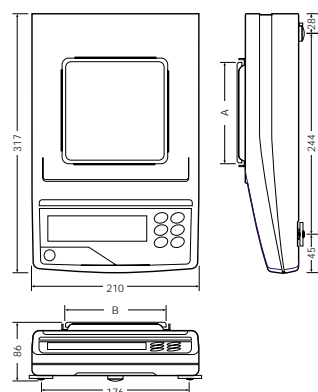

Pan size (mm)

Model	A	B
GF-200/300	128	128
GF-1200/2000/3000	165	165
GX-200/400/600	128	128
GX-6100/6000/8000	165	165

Dimensions with optional Glass Breeze Break (mm)

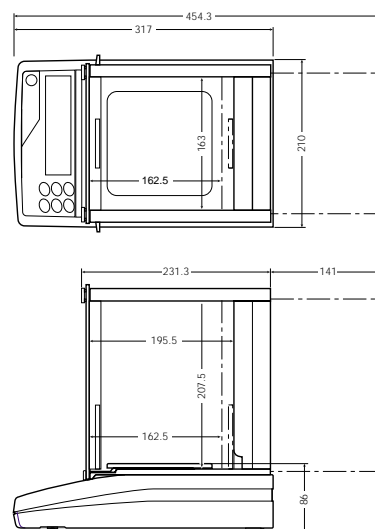

GX Specifications	GX-200-EC	GX-400-EC	GX-600-EC	GX-2000-EC	GX-4000-EC	GX-6100-EC	GX-6000-EC	GX-8000-EC
Weighing Capacity (Max)	210g	410 g	610g	2100g	4100g	6100g	6100g	8100g
Resolution (d)	0.001g			0.01g			0.1g	
Repeatability	0.001g			0.01g			0.1g	
Linearity	±0.002g		±0.003g	±0.02g		±0.03g	±0.1g	
Stabilization time	Approx. 1 second					Approx. 1.5 s	Approx. 1 second	
Sensing method	Super Hybrid Sensor (SHS)							
Display type	Vacuum Fluorescent Display (VFD)							
Sensitivity drift (10° C to 30° C/50° F to 86° F)	± 2ppm/°C (When automatic self calibration is not used)						± 5ppm/°C (auto-self calibration OFF)	
Counting	0.001g			0.01g			0.1g	
mode	Minimum unit mass			Number of samples			Minimum 100% reference mass	
	0.100g			5, 10, 25, 50 or 100 pieces			1.00g	
mode	Minimum 100% display			0.01%, 0.1%, 1% (depends on reference mass stored)				
Weighing units & modes	g, PC, PCT, OZ, Lb, L Oz, Ozt, ct, mm, dwt, GN, TL, DS, Mit, newtons							
Display refresh rate	5 times / second or 10 times / second							
Operating environment temperature	5° C to 40° C (41° F to 104° F), 85 % RH or less (No condensation)							
External dimensions	210 (W) x 317 (D) x 86 (H) mm							
AC adapter	Confirm that the adapter type is correct for the local voltage and power receptade							
Power consumption	Approx. 11VA (supplied by AC adapter)							
Standard serial I/F	RS-232C interface with WinCT (WinCT: included as CD-ROM)							
External calibration weight to be used	200g	400g	600g	2000g	4000g	6000g	6000g	8000g
	100g	300g	500g	1000g	3000g	5000g	5000g	7000g
		200g	400g		2000g	4000g	4000g	6000g
			300g			3000g	3000g	5000g
								4000g
Calibration	Motor-driven internal calibration with SHS							
Net weight	Approx. 4.6kg				Approx. 5.1kg			

GF Specifications	GF-200	GF-300	GF-1200	GF-2000	GF-3000	GF-6000
Weighing Capacity	210g	310 g	1210g	2100g	3100g	6100g
Resolution	0.001g		0.01g			0.1g
Repeatability	0.001g		0.01g			0.1g
Linearity	±0.002g		±0.02g			±0.1g
Stabilization time	Approx. one second (Typ. FAST response setting)					
Sensing method	Super Hybrid Sensor (SHS)					
Display type	Vacuum Fluorescent Display (VFD)					
Sensitivity drift (10° C to 30° C/50° F to 80° F)	± 2ppm/°C					± 5ppm/°C
Counting	0.001g		0.01g			0.1g
mode	Minimum unit mass		Number of samples			Minimum 100% reference mass
	0.100g		5, 10, 25, 50 or 100 pieces			1.00g
mode	Minimum 100% display		0.01%, 0.1%, 1% (depends on reference mass stored)			
Weighing units & modes	g, PC, PCT, OZ, Lb, L Oz, Ozt, ct, mm, dwt, GN, TL, DS, Mit, newtons					
Display refresh rate	5 times / second or 10 times / second					
Operating environment temperature	5° C to 40° C (41° F to 104° F), 85 % RH or less (No condensation)					
External dimensions	210 (W) x 317 (D) x 86 (H) mm					
AC adapter	Confirm that the adapter type is correct for the local voltage and power receptade					
Power consumption	Approx. 11VA (supplied by AC adapter)					
Standard serial I/F	RS-232C interface with WinCT (WinCT: included as CD-ROM)					
External calibration weight to be used	200g	300g	1000g	2000g	3000g	6000g
	100g	200g	500g	1000g	2000g	5000g
		100g			1000g	4000g
						3000g
						2000g
Weighing pan	128 x 128 mm			165 x 165 mm		
Net weight	Approx. 3.8kg			Approx. 4.3kg		

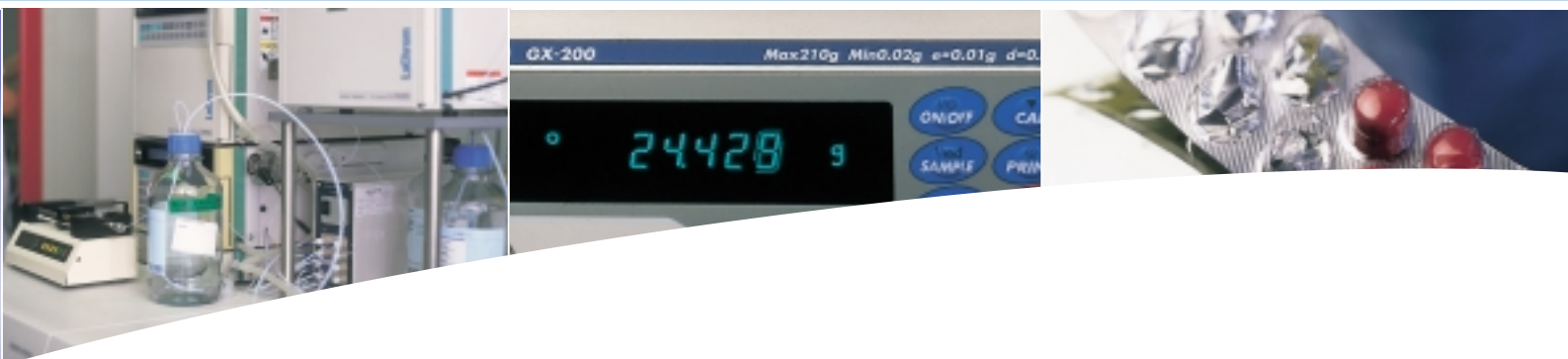

With Time & Date Clock, GLP-Compliance and WinCT as standard. Plus all the other features you need.

- **GLP/GMP/ISO Compliance**

Allows GLP or LIMS balance management by outputting and the balance ID Number and data used to calibrate the balance. The data can be output to A&D's AD-8121 or DP-1012 printer or a computer, indicating date, time, balance ID Number, serial number and calibration data.

- **Standard Windows Communication Tools Software WinCT**

WinCT provides easy transmission of weighing data from a GX or GF balance to a computer using the RS-232 C interface. Quickly exports data into Windows applications in a manageable format limited only by the computers capabilities.

- **RS-232C Interface**

Incorporates bi-directional communication with a PC, printer or other peripheral device.

- **Density Calculation Mode**

Automatically calculates and displays the density measurement results;

- Input the temperature of water,
- Input the liquid's density directly (Range: 0.000 – 1.9999g/cm³)

- **Data Memory – GX**

Format the Data Memory Function for:

- 200 sets of weighing data
- 100 sets of weighing data with Time & Date
- 50 sets of GLP Data – Time & Date, Calibration Data, ID Number and Serial number
- 20 sets of Unit Weight for Counting Mode

- **Data Memory – GF**

Format the Data Memory Function for:

- 40 sets of weighing data
- 20 sets of Unit Weight for Counting Mode

- **Time & Date – GX**

Standard Time & Date Function complies with GLP and Interval Weighing in the Data Memory Function.

- **Commands**

A PC can control the balance by sending commands to the balance. Commands to query weighing data; to control the balance; to control the memory function, to control comparator function.

- **Internal Calibration - GX**

All GX balances provide an internal calibration and perform self calibration using the internal mass when the balance detects ambient temperature changes. The One-Touch Calibration lets you adjust the calibration on demand at the press of a single button.

- **Standard Underhook**

Ideal for density determination and weighing magnetic and highly static objects.

- **Interval Time Setting**

Weighing intervals of 2, 5, 10 minutes in the Data Memory Function.

- **Auto Self Checking**

Automatically checks itself when setting the Automatic Adjustable Environment.

- **Auto Re-Zero**

Re-zeroes automatically after data output.

- **Large Square Weighing Pan**

Standard large square weighing pan on all models.

GX200/400/600:	128 x 128 mm
GF200/300:	128 x 128 mm
GX2000, 4000, 6100, 6000, 8000:	165 x 165 mm
GF1200, 2000, 3000, 6000:	165 x 165 mm

- **Multiple Weighing Units and Programmable Unit**

Uses programmable or standard units of measure (g, ct, newtons, plus many more including a free unit which can be set by the operator)

- **Front Air Bubble Leveling**

Easy check the balance's level from the front.

- **Quick Reference Card**

A fast, convenient operating guide installed at the bottom of the balance.

GX/GF Series

GX/GF at a glance:

- Capacity and Resolution:
210g/0.001g ~ 8100g/0.1g
- Response speed: just 1 second
- Applications:
counting, percentage, animal, comparator, density (GX)
- EC type Approval (GX)
- Time & Date clock (GX)
- GLP-Compliance
- Robust metal Housing
- Internal (GX) or external (GF) calibration
- Automatic environmental adjustment
- WinCT Communication Software
- Standard RS-232C
- Large Square Weighing Pan
- Brilliant easy-to-read VFD-Display
- Data Memory Function
- Quick Reference Card
- 4-year-warranty

Also ask for information on:

SHS - Sensor Series

GP – the series for the highest of expectations



Extremely efficient and robust. Introducing the new GP precision balances:

- Range between 12 and 101 kg
- Results delivered in just 1 second
- Outstandingly user-friendly
- Automatic internal calibration
- Protected in accordance with IP-65
- Conforms to GLP standards
- Plus many other features

AD-4212 Production Weighing System

Compact weighing unit can be placed anywhere in the production line.



All named trademarks are the trademarks of their respective owners.

Specifications are subject to change for improvement without notice.



Unit 24/26 Blacklands Way, Abingdon Business Park,
Abingdon, Oxon, OX14 1DY, United Kingdom
Telephone: +44 (0) 1235 550420 Fax: +44 (0) 1235 550485
www.aandd-eu.net

German Sales Office

Große Straße 13b, D-22926 Ahrensburg, Germany
Telephone: +49 (0) 41 02 45 92 30 Fax: +49 (0) 41 02 45 92 31
www.aandd.de